

Version Lateral module - 60 cm
Collection Elements

TECHNICAL FEATURES

Materials/Finishes Aluminium finishing black matt
Materials/Finishes Smoked tempered glass
Function Extracting/Filtering
Lighting Strip LED - 2700 K / 5600 K

CONNECTION AND CONSUMPTION FUNCTIONS

Maximum consumption 10 W
Voltage/Frequency

MOTOR

Motor
Maximum capacity
Maximum sound level
Energy class

WEIGHTS AND VOLUMES

Gross weight 6.9 kg
Net weight 5 kg
Volume 0 m³
Packaging dimensions L 700 x H 207 x P 235 mm

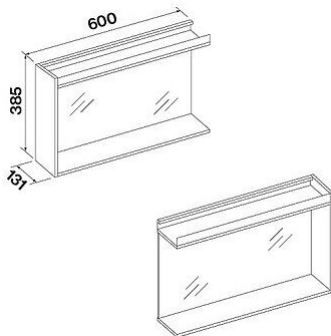

FLOW RATE / PRESSURE